



DESCRIPTION

The DRS1AF~DRS1MF are available in SMAF Package

FEATURES

- For surface mounted applications
- Low profile package
- Glass Passivated Chip Junction
- Easy to pick and place
- Fast reverse recovery time
- Available in SMAF Package

ORDERING INFORMATION

Package Type	Part Number
SMAF	DRS1AF
	DRS1BF
	DRS1DF
	DRS1GF
	DRS1JF
	DRS1KF
	DRS1MF
Note	SPQ: 3,000pcs/Reel
AiT provides all RoHS Compliant Products	

MECHANICAL DATA

Case: SMAF

Terminals: Solderable per MIL-STD-750,
Method 2026

Approx. Weight: 27mg 0.00086oz

PIN DESCRIPTION





MAXIMUM RATINGS AND ELECTRICAL CHARACTERISTICS

Ratings at 25°C ambient temperature unless otherwise specified. Single phase half-wave 60 Hz, resistive or inductive load, for capacitive load current derate by 20 %.

Parameter	Symbol	DRS1AF	DRS1BF	DRS1DF	DRS1GF	DRS1JF	DRS1KF	DRS1MF	Unit
Maximum Repetitive Peak Reverse Voltage	V_{RRM}	50	100	200	400	600	800	1000	V
Maximum RMS Voltage	V_{RMS}	35	70	140	280	420	560	700	V
Maximum DC Blocking Voltage	V_{DC}	50	100	200	400	600	800	1000	V
Maximum Average Forward Rectified Current at $T_A=65^\circ\text{C}$	$I_{F(AV)}$	1.0							A
Peak Forward Surge Current 8.3ms Single Half Sine Wave Superimposed on Rated Load (JEDEC Method)	I_{FSM}	25							A
Maximum Instantaneous Forward Voltage at 1A	V_F	1.3							V
Maximum DC Reverse Current at Rated DC Blocking Voltage	I_R	$T_A=25^\circ\text{C}$ 5.0 $T_A=125^\circ\text{C}$ 100							μA
Maximum Reverse Recovery Time ^{NOTE1}	t_{rr}	150				250	500		ns
Typical Junction Capacitance ^{NOTE2}	C_J	15							pF
Operating and Storage Temperature Range	T_J, T_{STG}	-55 ~150							$^\circ\text{C}$

NOTE1: Measured with $I_F=0.5\text{A}$, $I_R=1\text{A}$, $I_{rr}=0.25\text{A}$

NOTE2: Measured at 1MHz and applied reverse voltage of 4V D.C



TYPICAL CHARACTERISTICS

Figure. 1 Forward Current Derating Curve

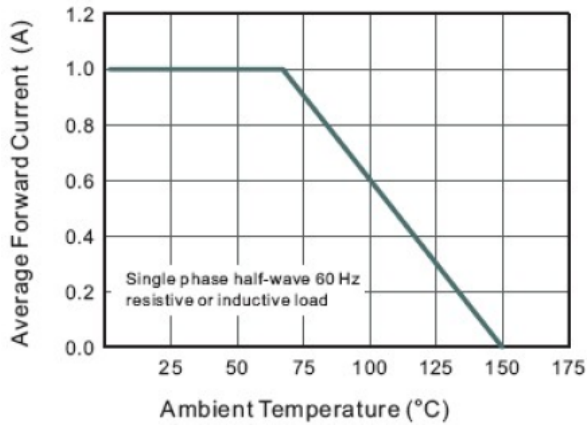

Figure. 2 Typical Reverse Characteristics

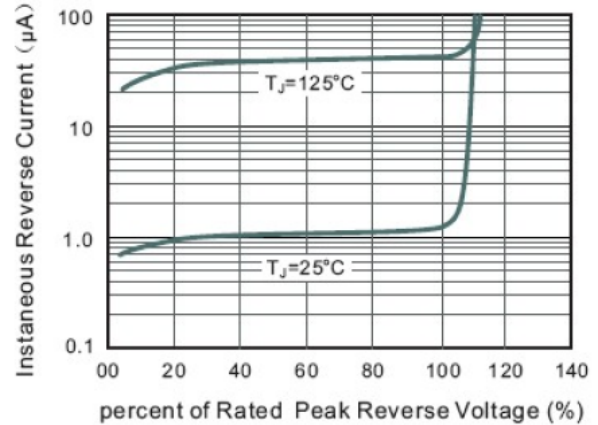

Figure. 3 Typical Instantaneous Forward Characteristics

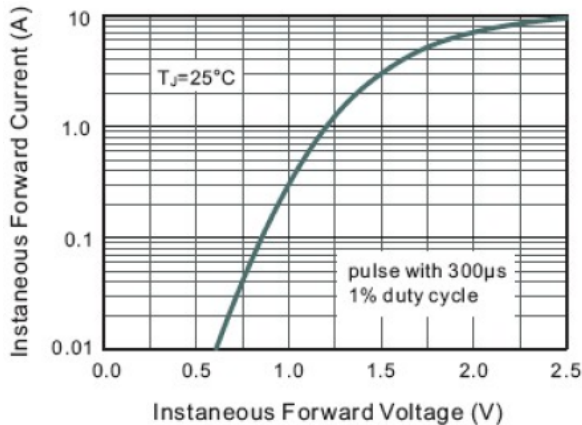

Figure. 4 Typical Junction Capacitance

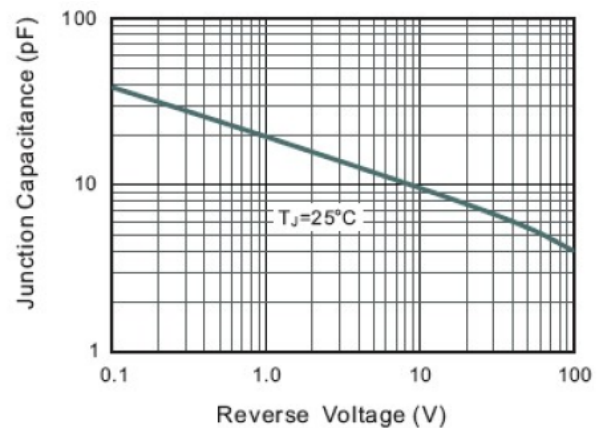
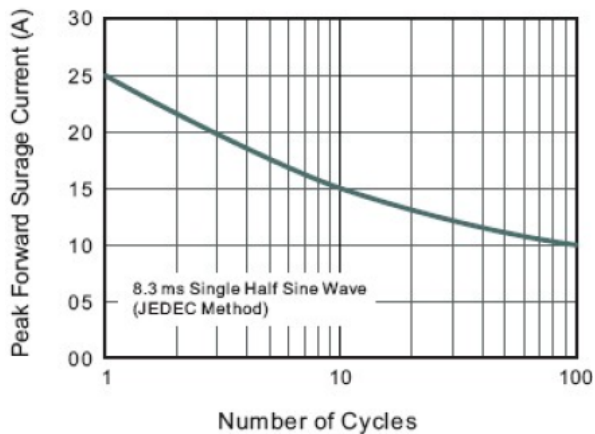

Figure. 5 Maximum Non-Repetitive Peak Forward Surge Current





PACKAGE INFORMATION

Dimension in SMAF (Unit: mm)

Plastic surface mounted package; 2 leads

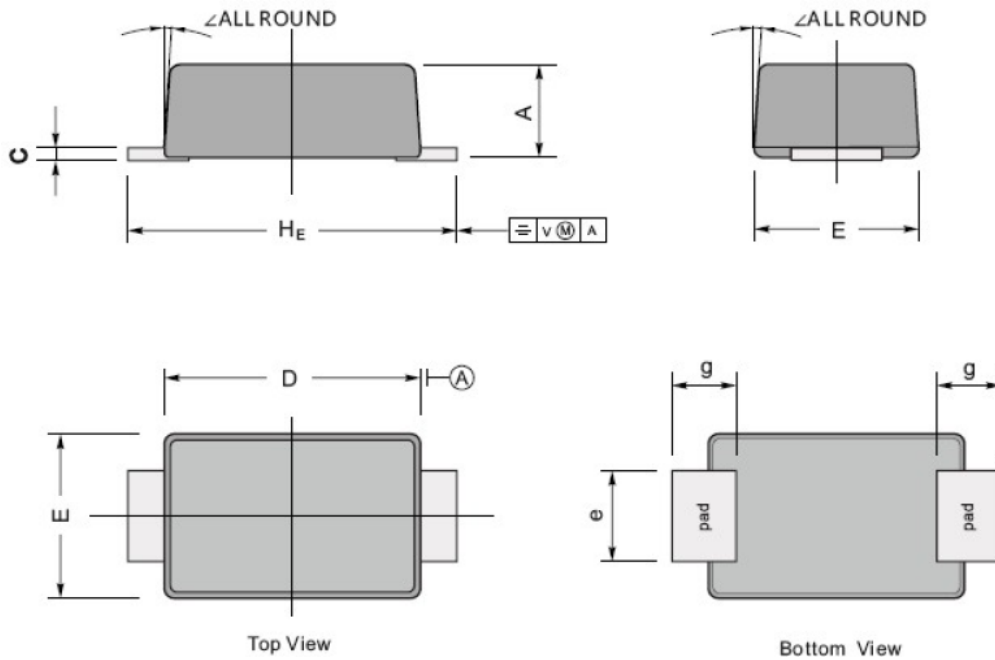

The recommended mounting pad size

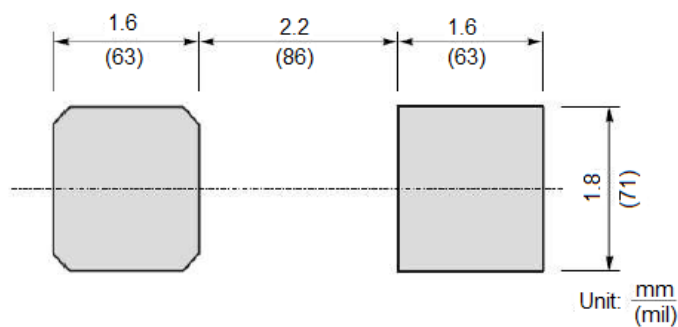

UNIT		A	c	D	E	e	g	H_E	\angle
mm	Max	1.1	0.20	3.7	2.7	1.6	1.2	4.9	7°
	Min	0.9	0.12	3.3	2.4	1.3	0.8	4.4	
mil	Max	43	7.9	146	106	63	47	193	
	Min	35	4.7	130	94	51	31	173	



IMPORTANT NOTICE

AiT Components (AiT) reserves the right to make changes to any its product, specifications, to discontinue any integrated circuit product or service without notice, and advises its customers to obtain the latest version of relevant information to verify, before placing orders, that the information being relied on is current.

AiT Components' integrated circuit products are not designed, intended, authorized, or warranted to be suitable for use in life support applications, devices or systems or other critical applications. Use of AiT products in such applications is understood to be fully at the risk of the customer. As used herein may involve potential risks of death, personal injury, or severe property, or environmental damage. In order to minimize risks associated with the customer's applications, the customer should provide adequate design and operating safeguards.

AiT Components assumes no liability to customer product design or application support. AiT warrants the performance of its products of the specifications applicable at the time of sale.