



DESCRIPTION

The DS12W~DS120W are available in SOD-123FL Package.

ORDERING INFORMATION

Package Type	Part Number
SOD-123FL	DS12W
	DS14W
	DS16W
	DS18W
	DS110W
	DS112W
	DS115W
	DS120W
Note	SPQ: 3,000pcs/Reel
AiT provides all RoHS Compliant Products	

PIN DESCRIPTION



FEATURES

- For surface mounted applications
- Low power loss, high efficiency
- High forward surge current capability
- For use in low voltage, high frequency inverters, free wheeling, and polarity protection applications
- Metal silicon junction, majority carrier conduction
- Available in SOD-123FL Package

MECHANICAL DATA

Case: SOD-123FL

Terminals: Solderable per MIL-STD-750,
Method 2026

Approx. Weight: 15mg 0.00048oz



ABSOLUTE MAXIMUM RATINGS AND ELECTRICAL CHARACTERISTICS

Ratings at 25°C ambient temperature unless otherwise specified. Single phase, half wave, 60Hz resistive or inductive load, for capacitive load, derate by 20 %

Parameter	Symbol	DS12W	DS14W	DS16W	DS18W	DS110W	DS112W	DS115W	DS120W	Unit
Maximum Repetitive Peak Reverse Voltage	V_{RRM}	20	40	60	80	100	120	150	200	V
Maximum RMS Voltage	V_{RMS}	14	28	42	56	70	84	105	140	V
Maximum DC Blocking Voltage	V_{DC}	20	40	60	80	100	120	150	200	V
Maximum Average Forward Rectified Current	$I_{F(AV)}$	1.0								A
Peak Forward Surge Current 8.3ms Single Half Sine Wave Superimposed on Rated Load (JEDEC Method)	I_{FSM}	40				30				A
Max Instantaneous Forward Voltage at 1A	V_F	0.55	0.70		0.85		0.90		V	
Maximum DC Reverse Current at Rated DC Blocking Voltage	I_R	$T_A=25^\circ C$		0.3		0.2		0.1		mA
		$T_A=100^\circ C$		10		5.0		2		
Typical Junction Capacitance ^{NOTE1}	C_J	110	80				pF			
Typical Thermal Resistance ^{NOTE2}	$R_{\theta JA}$	115								°C/W
Operating Junction Temperature Range	T_J	-55 ~ +125								°C
Storage Temperature Range	T_{STG}	-55 ~ +150								°C

NOTE1: Measured at 1MHz and applied reverse voltage of 4V D.C.

NOTE2: P.C.B. mounted with 0.2 x 0.2" (5 x 5 mm) copper pad areas.



TYPICAL CHARACTERISTICS

Figure. 1 Forward Current Derating Curve

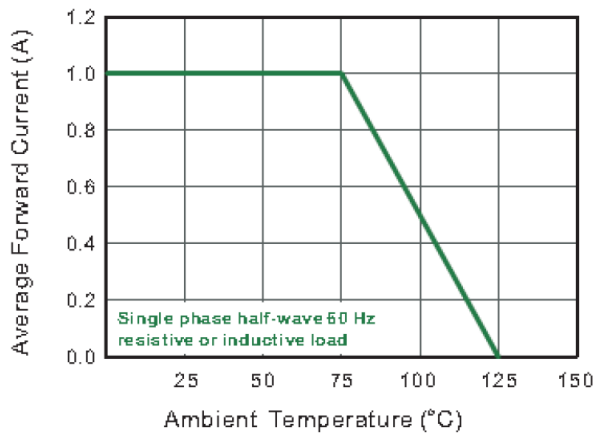

Figure. 2 Typical Reverse Characteristics

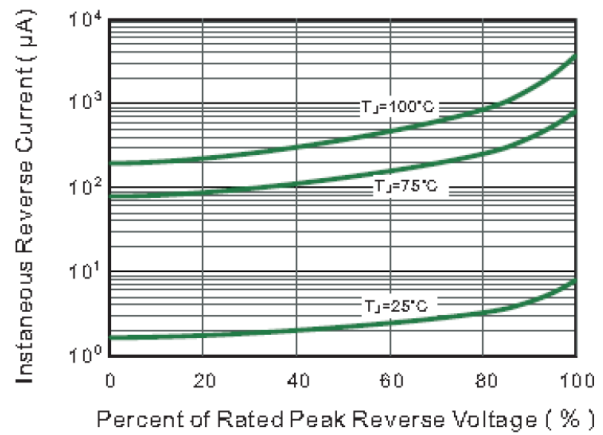

Figure. 3 Typical Forward Characteristic

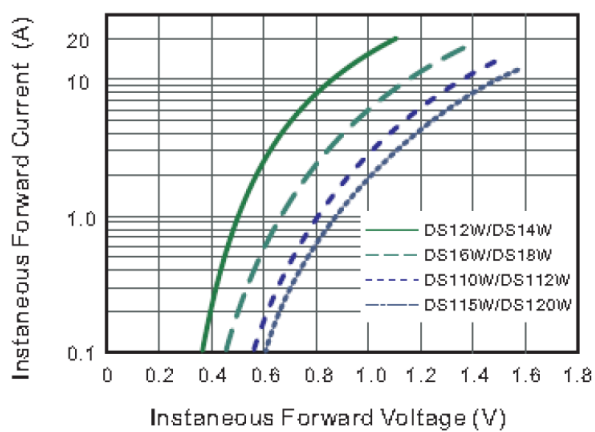

Figure. 4 Typical Junction Capacitance

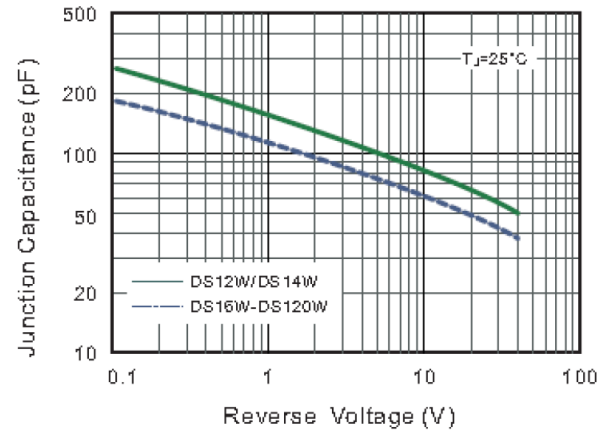

Figure. 5 Maximum Non-Repetitive Peak Forward Surge Current

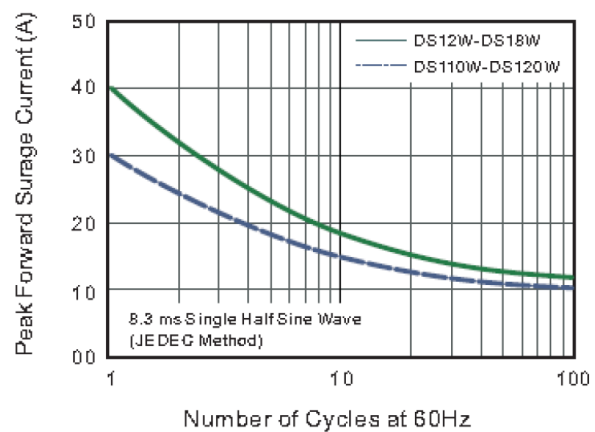
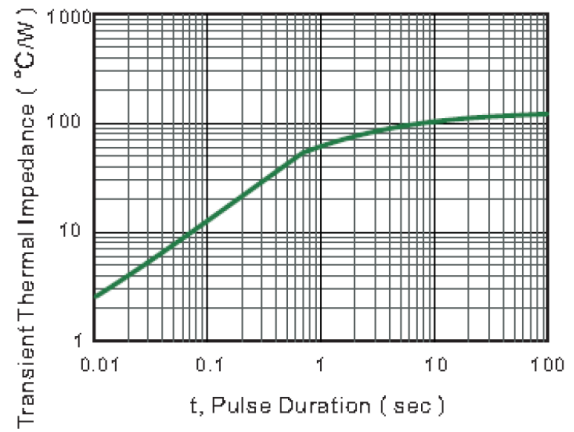

Figure. 6 Typical Transient Thermal Impedance





PACKAGE INFORMATION

Dimension in SOD-123FL (Unit: mm)

Plastic surface mounted package; 2 leads

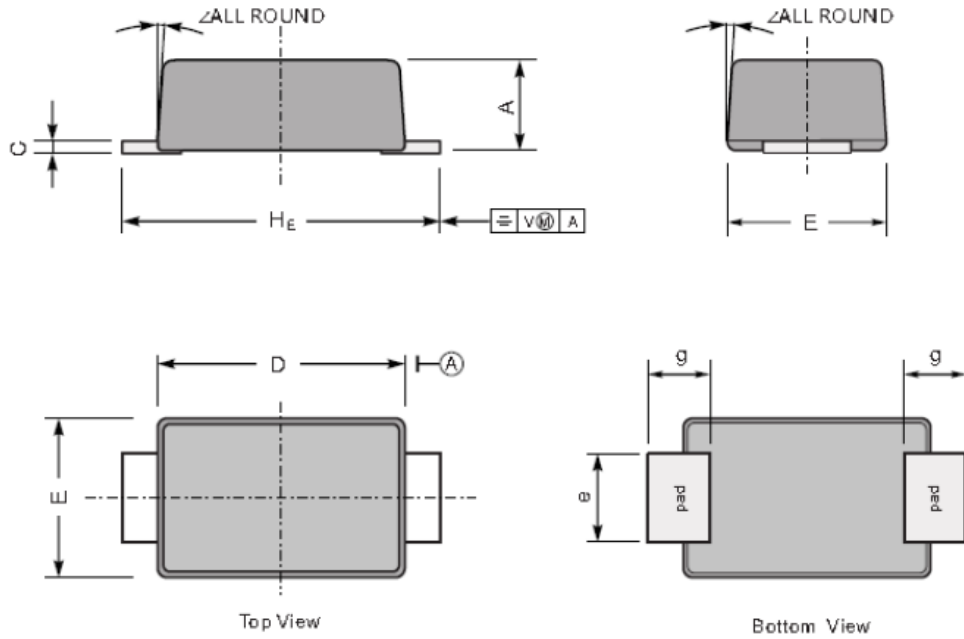

The recommended mounting pad size

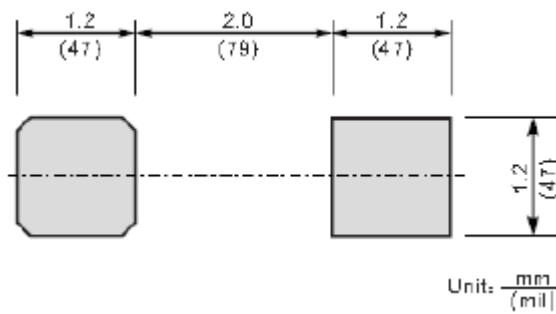

Unit: $\frac{mm}{(mil)}$

UNIT		A	C	D	E	e	g	H _E	\angle
mm	Max	1.1	0.20	2.9	1.9	1.1	0.9	3.8	7°
	Min	0.9	0.12	2.6	1.7	0.8	0.7	3.5	
mil	Max	43	7.9	114	75	43	35	150	
	Min	35	4.7	102	67	31	23	138	



IMPORTANT NOTICE

AiT Components (AiT) reserves the right to make changes to any its product, specifications, to discontinue any integrated circuit product or service without notice, and advises its customers to obtain the latest version of relevant information to verify, before placing orders, that the information being relied on is current.

AiT Components' integrated circuit products are not designed, intended, authorized, or warranted to be suitable for use in life support applications, devices or systems or other critical applications. Use of AiT products in such applications is understood to be fully at the risk of the customer. As used herein may involve potential risks of death, personal injury, or severe property, or environmental damage. In order to minimize risks associated with the customer's applications, the customer should provide adequate design and operating safeguards.

AiT Components assumes no liability to customer product design or application support. AiT warrants the performance of its products of the specifications applicable at the time of sale.