



## DESCRIPTION

The SM320AF~SM3200AF are available in SMAF Package

## ORDERING INFORMATION

Package Type	Part Number
SMAF	SM320AF
	SM340AF
	SM360AF
	SM380AF
	SM3100AF
	SM3120AF
	SM3150AF
	SM3200AF
Note	3,000pcs/Reel
AiT provides all RoHS Compliant Products	

## PIN DESCRIPTION



1. CATHODE
2. ANODE

## FEATURES

- Metal silicon junction, majority carrier conduction
- For surface mounted applications
- Low power loss, high efficiency
- High forward surge current capability
- For use in low voltage, high frequency inverters, free wheeling, and polarity protection applications
- Available in SMAF Package

## MECHANICAL DATA

Case: SMAF

Terminals: Solderable per MIL-STD-750,  
Method 2026

Approx. Weight:27mg 0.00086oz



## ABSOLUTE MAXIMUM RATINGS AND ELECTRICAL CHARACTERISTICS

Ratings at 25°C ambient temperature unless otherwise specified. Single phase, half wave, 60Hz resistive or inductive load, for capacitive load, derate by 20 %

Parameter	Symbol	SM 320AF	SM 340AF	SM 360AF	SM 380AF	SM 3100AF	SM 3120AF	SM 3150AF	SM 3200AF	Unit
Maximum Repetitive Peak Reverse Voltage	V <sub>RRM</sub>	20	40	60	80	100	120	150	200	V
Maximum RMS Voltage	V <sub>RMS</sub>	14	28	42	56	70	84	105	140	V
Maximum DC Blocking Voltage	V <sub>DC</sub>	20	40	60	80	100	120	150	200	V
Maximum Average Forward Rectified Current	I <sub>F(AV)</sub>	3.0								A
Peak Forward Surge Current 8.3ms Single Half Sine-Wave Superimposed on Rated Load (JEDEC Method)	I <sub>FSM</sub>	80				70				A
Max Instantaneous Forward Voltage at 3A	V <sub>F</sub>	0.55		0.70		0.85		0.95		V
Maximum DC Reverse Current at Rated DC Reverse Voltage	I <sub>R</sub>	T <sub>A</sub> =25°C		0.5		0.3		0.3		mA
		T <sub>A</sub> =100°C		10		5.0		5.0		
Typical Junction Capacitance <small>NOTE1</small>	C <sub>J</sub>	250		160						pF
Typical Thermal Resistance <small>NOTE2</small>	R <sub>θJA</sub>	40								°C/W
Operating Junction Temperature Range	T <sub>J</sub>	-55 ~125								°C
Storage Temperature Range	T <sub>STG</sub>	-55 ~150								°C

NOTE1: Measured at 1MHz and applied reverse voltage of 4V D.C.

NOTE2: P.C.B. mounted with 0.2 X 0.2" (5 X 5 mm) copper pad areas.



## TYPICAL CHARACTERISTICS

Figure. 1 Forward Current Derating Curve

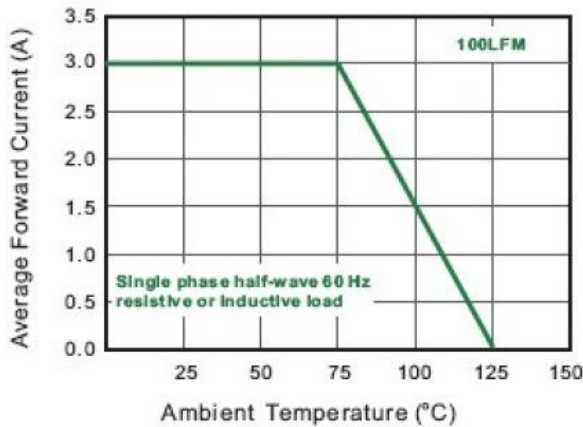

Figure. 2 Typical Reverse Characteristics

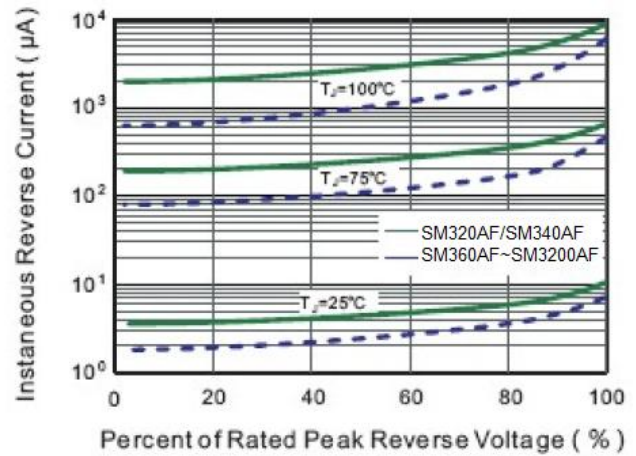

Figure. 3 Typical Forward Characteristic

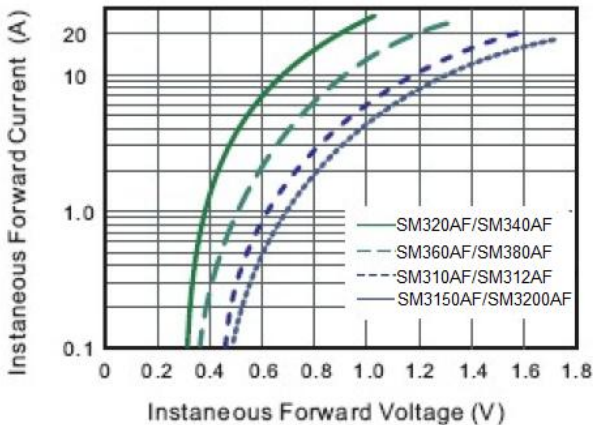

Figure. 4 Typical Junction Capacitance

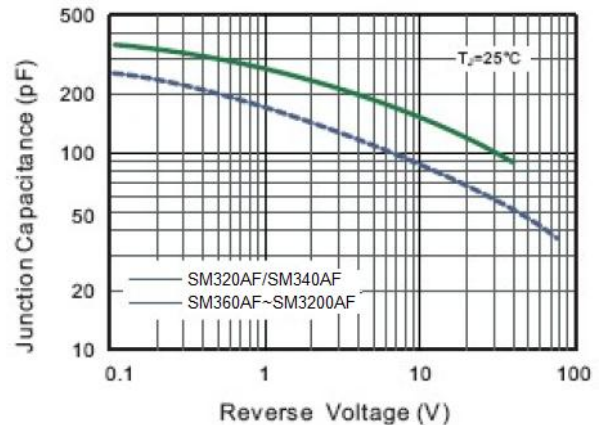

Figure. 5 Maximum Non-Repetitive Peak Forward Surge Current

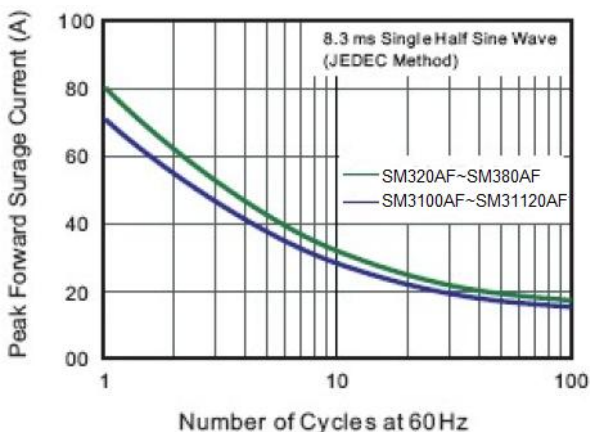
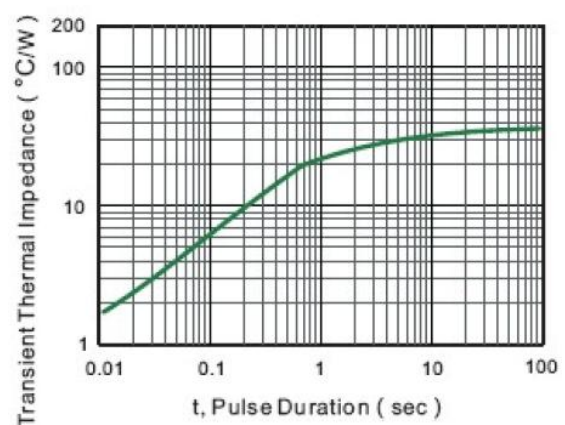

Figure. 6 Typical Transient Thermal Impedance





**PACKAGE INFORMATION**

Dimension in SMAF (Unit: mm)

Plastic surface mounted package; 2 leads

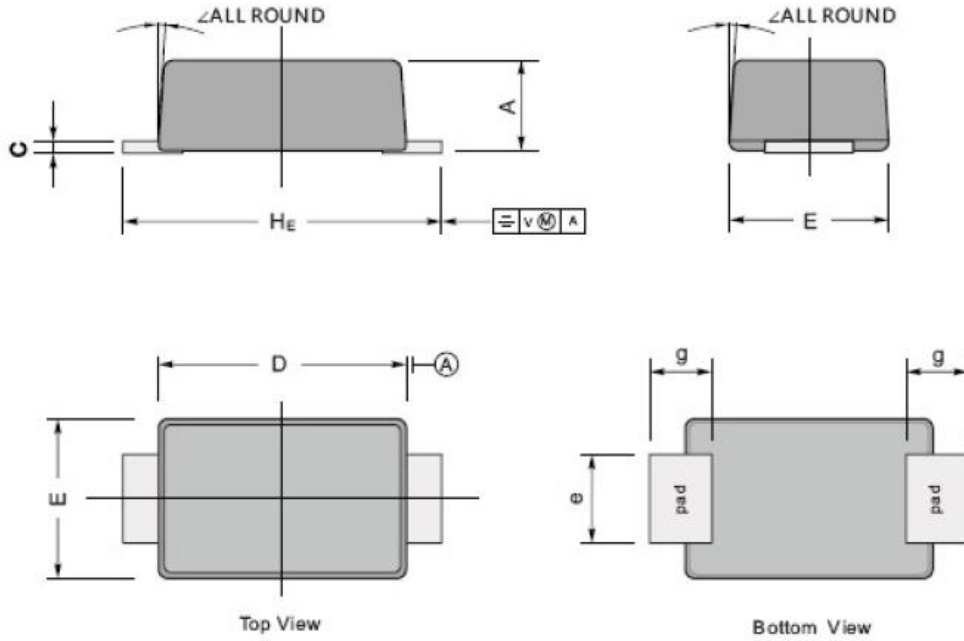

The recommended mounting pad size



Unit: mm(mil)

UNIT		A	B	C	E	e	g	H <sub>E</sub>	$\angle$
mm	Max	1.3	0.23	3.7	2.7	1.6	1.3	4.9	7°
	Min	1.1	0.18	3.3	2.4	1.3	1.0	4.4	
mil	Max	51	9.1	146	106	63	51	193	
	Min	43	7.1	130	94	51	39	173	



## IMPORTANT NOTICE

AiT Components (AiT) reserves the right to make changes to any its product, specifications, to discontinue any integrated circuit product or service without notice, and advises its customers to obtain the latest version of relevant information to verify, before placing orders, that the information being relied on is current.

AiT Components' integrated circuit products are not designed, intended, authorized, or warranted to be suitable for use in life support applications, devices or systems or other critical applications. Use of AiT products in such applications is understood to be fully at the risk of the customer. As used herein may involve potential risks of death, personal injury, or severe property, or environmental damage. In order to minimize risks associated with the customer's applications, the customer should provide adequate design and operating safeguards.

AiT Components assumes no liability to customer product design or application support. AiT warrants the performance of its products of the specifications applicable at the time of sale.