



## DESCRIPTION

The MBT3946D device is a spin-off of our popular SOT-23/SOT-323 three-leaded device. It is designed for general purpose amplifier applications and is housed in the SOT-363 six-leaded surface mount package. By putting two discrete devices in one package, this device is ideal for low-power surface mount applications where board space is at a premium.

The MBT3946D is available in SC-88 Package.

## FEATURES

- $h_{FE}$ , 100–300
- Low  $V_{CE(sat)}$ , < 0.4 V
- Simplifies Circuit Design
- Reduces Board Space
- Reduces Component Count
- ROHS compliance
- Available in SC-88 Package

## ORDERING INFORMATION

Package Type	Part Number
SC-88	MBT3946D
Note	3,000pcs/ Reel
AiT provides all RoHS Compliant Products	

## PIN DESCRIPTION

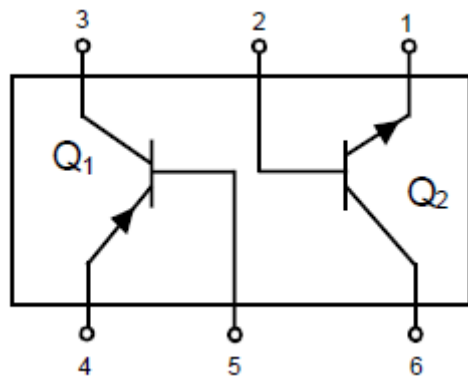

MBT3946D\*

\*Q1 PNP    Q2 NPN



## ABSOLUTE MAXIMUM RATINGS

$V_{CEO}$ , Collector-Emitter Voltage	NPN / PNP	40Vdc / -40Vdc
$V_{CBO}$ , Collector-Base Voltage	NPN / PNP	60Vdc / -40Vdc
$V_{EBO}$ , Emitter-Base Voltage	NPN / PNP	6.0Vdc / - 5.0Vdc
$I_C$ , Collector Current-Continuous	NPN / PNP	200mAdc / -200mAdc

Stresses above may cause permanent damage to the device. These are stress ratings only and functional operation of the device at these or any other conditions beyond those indicated in the Electrical Characteristics are not implied. Exposure to absolute maximum rating conditions for extended periods may affect device reliability.

## THERMAL CHARACTERISTICS

Parameter	Symbol	Max	Unit
Total Package Dissipation <sup>NOTE1</sup> $T_A = 25^\circ\text{C}$	$P_D$	150	mW
Thermal Resistance, Junction to Ambient	$R_{\theta JA}$	833	$^\circ\text{C}/\text{W}$
Junction and Storage Temperature	$T_J, T_{STG}$	-55 to +150	$^\circ\text{C}$

NOTE1: Device mounted on FR4 glass epoxy printed circuit board using the minimum recommended footprint



## ELECTRICAL CHARACTERISTICS

T<sub>A</sub> = 25°C, unless otherwise noted

Parameter	Symbol	Conditions	Min	Max	Unit	
<b>OFF CHARACTERISTICS</b>						
Collector–Emitter Breakdown Voltage <sup>NOTE2</sup>	V <sub>(BR)CEO</sub>	I <sub>C</sub> = 1.0mA <sub>dc</sub> , I <sub>B</sub> = 0	NPN	40	-	V <sub>dc</sub>
		I <sub>C</sub> = -1.0mA <sub>dc</sub> , I <sub>B</sub> = 0	PNP	-40	-	
Collector–Base Breakdown Voltage	V <sub>(BR)CBO</sub>	I <sub>C</sub> = 10μA <sub>dc</sub> , I <sub>E</sub> = 0	NPN	60	-	V <sub>dc</sub>
		I <sub>C</sub> = -10μA <sub>dc</sub> , I <sub>E</sub> = 0	PNP	-40	-	
Emitter–Base Breakdown Voltage	V <sub>(BR)EBO</sub>	I <sub>E</sub> = 10μA <sub>dc</sub> , I <sub>C</sub> = 0	NPN	6.0	-	V <sub>dc</sub>
		I <sub>E</sub> = -10μA <sub>dc</sub> , I <sub>C</sub> = 0	PNP	-5.0	-	
Base Cutoff Current	I <sub>BL</sub>	V <sub>CE</sub> = 30V <sub>dc</sub> , V <sub>EB</sub> = 3.0V <sub>dc</sub>	NPN	-	50	nA <sub>dc</sub>
		V <sub>CE</sub> = -30V <sub>dc</sub> , V <sub>EB</sub> = -3.0V <sub>dc</sub>	PNP	-	-50	
Collector Cutoff Current	I <sub>CEx</sub>	V <sub>CE</sub> = 30V <sub>dc</sub> , V <sub>EB</sub> = 3.0V <sub>dc</sub>	NPN	-	50	nA <sub>dc</sub>
		V <sub>CE</sub> = -30V <sub>dc</sub> , V <sub>EB</sub> = -3.0V <sub>dc</sub>	PNP	-	-50	
<b>ON CHARACTERISTICS<sup>NOTE2</sup></b>						
DC Current Gain	h <sub>FE</sub>	I <sub>C</sub> = 0.1mA <sub>dc</sub> , V <sub>CE</sub> = 1.0V <sub>dc</sub>	NPN	40	-	-
		I <sub>C</sub> = 1.0mA <sub>dc</sub> , V <sub>CE</sub> = 1.0V <sub>dc</sub>		70	-	
		I <sub>C</sub> = 10mA <sub>dc</sub> , V <sub>CE</sub> = 1.0V <sub>dc</sub>		100	300	
		I <sub>C</sub> = 50mA <sub>dc</sub> , V <sub>CE</sub> = 1.0V <sub>dc</sub>		60	-	
		I <sub>C</sub> = 100mA <sub>dc</sub> , V <sub>CE</sub> = 1.0V <sub>dc</sub>		30	-	
		I <sub>C</sub> = -0.1mA <sub>dc</sub> , V <sub>CE</sub> = -1.0V <sub>dc</sub>	PNP	60	-	
		I <sub>C</sub> = -1.0mA <sub>dc</sub> , V <sub>CE</sub> = -1.0V <sub>dc</sub>		80	-	
		I <sub>C</sub> = -10mA <sub>dc</sub> , V <sub>CE</sub> = -1.0V <sub>dc</sub>		100	300	
		I <sub>C</sub> = -50mA <sub>dc</sub> , V <sub>CE</sub> = -1.0V <sub>dc</sub>		60	-	
		I <sub>C</sub> = -100mA <sub>dc</sub> , V <sub>CE</sub> = -1.0V <sub>dc</sub>		30	-	
Collector–Emitter Saturation Voltage	V <sub>CE(SAT)</sub>	I <sub>C</sub> = 10mA <sub>dc</sub> , I <sub>B</sub> = 1.0mA <sub>dc</sub>	NPN	-	0.2	V <sub>dc</sub>
		I <sub>C</sub> = 50mA <sub>dc</sub> , I <sub>B</sub> = 5.0mA <sub>dc</sub>		-	0.3	
		I <sub>C</sub> = -10mA <sub>dc</sub> , I <sub>B</sub> = -1.0mA <sub>dc</sub>	PNP	-	-0.25	
		I <sub>C</sub> = -50mA <sub>dc</sub> , I <sub>B</sub> = -5.0mA <sub>dc</sub>		-	-0.4	
Base–Emitter Saturation Voltage	V <sub>BE(SAT)</sub>	I <sub>C</sub> = 10mA <sub>dc</sub> , I <sub>B</sub> = 1.0mA <sub>dc</sub>	NPN	0.65	0.85	V <sub>dc</sub>
		I <sub>C</sub> = 50mA <sub>dc</sub> , I <sub>B</sub> = 5.0mA <sub>dc</sub>		-	0.95	
		I <sub>C</sub> = -10mA <sub>dc</sub> , I <sub>B</sub> = -1.0mA <sub>dc</sub>	PNP	-0.65	-0.85	
		I <sub>C</sub> = -50mA <sub>dc</sub> , I <sub>B</sub> = -5.0mA <sub>dc</sub>		-	-0.95	

NOTE2: Pulse Test: Pulse Width ≤ 300μs; Duty Cycle ≤ 2.0%.



T<sub>A</sub> = 25°C, unless otherwise noted

Parameter	Symbol	Conditions	Min	Max	Unit	
<b>SMALL-SIGNAL CHARACTERISTICS</b>						
Current-Gain-Bandwidth Product	f <sub>T</sub>	I <sub>C</sub> =10mA <sub>dc</sub> , V <sub>CE</sub> =20V <sub>dc</sub> , f = 100MHz	NPN	300	-	MHz
		I <sub>C</sub> =-10mA <sub>dc</sub> , V <sub>CE</sub> =-20V <sub>dc</sub> , f = 100MHz	PNP	250	-	
Output Capacitance	C <sub>obo</sub>	V <sub>CB</sub> = 5.0V <sub>dc</sub> , I <sub>E</sub> = 0, f = 1.0MHz	NPN	-	4.0	pF
		V <sub>CB</sub> = -5.0V <sub>dc</sub> , I <sub>E</sub> = 0, f = 1.0MHz	PNP	-	4.5	
Input Capacitance	C <sub>ibo</sub>	V <sub>EB</sub> = 0.5V <sub>dc</sub> , I <sub>C</sub> = 0, f = 1.0MHz	NPN	-	8.0	pF
		V <sub>EB</sub> = -0.5V <sub>dc</sub> , I <sub>C</sub> = 0, f = 1.0MHz	PNP	-	10.0	
Input Impedance	h <sub>ie</sub>	V <sub>CE</sub> = 10V <sub>dc</sub> , I <sub>C</sub> =1.0mA <sub>dc</sub> , f = 1.0kHz	NPN	1.0	10	KΩ
		V <sub>CE</sub> = -10V <sub>dc</sub> , I <sub>C</sub> =-1.0mA <sub>dc</sub> , f = 1.0kHz	PNP	2.0	12	
Voltage Feedback Ratio	h <sub>re</sub>	V <sub>CE</sub> =10V <sub>dc</sub> , I <sub>C</sub> =1.0mA <sub>dc</sub> , f = 1.0kHz	NPN	0.5	8.0	X10 <sup>-4</sup>
		V <sub>CE</sub> =-10V <sub>dc</sub> , I <sub>C</sub> =-1.0mA <sub>dc</sub> , f = 1.0kHz	PNP	0.1	10	
Small-Signal Current Gain	h <sub>FE</sub>	V <sub>CE</sub> =10V <sub>dc</sub> , I <sub>C</sub> =1.0mA <sub>dc</sub> , f = 1.0kHz	NPN	100	400	-
		V <sub>CE</sub> =-10V <sub>dc</sub> , I <sub>C</sub> =-1.0mA <sub>dc</sub> , f = 1.0kHz	PNP	100	400	
Output Admittance	h <sub>oe</sub>	V <sub>CE</sub> =10V <sub>dc</sub> , I <sub>C</sub> =1.0mA <sub>dc</sub> , f = 1.0kHz	NPN	1.0	40	μmhos
		V <sub>CE</sub> =-10V <sub>dc</sub> , I <sub>C</sub> =-1.0mA <sub>dc</sub> , f = 1.0kHz	PNP	3.0	60	
Noise Figure	NF	V <sub>CE</sub> =5.0V <sub>dc</sub> , I <sub>C</sub> =100μA <sub>dc</sub> , R <sub>S</sub> =1.0kΩ, f = 1.0kHz	NPN	5.0	-	dB
		V <sub>CE</sub> =-5.0V <sub>dc</sub> , I <sub>C</sub> =-100μA <sub>dc</sub> , R <sub>S</sub> =1.0kΩ, f = 1.0kHz	PNP	4.0	-	
<b>SWITCHING CHARACTERISTICS</b>						
Delay Time	t <sub>d</sub>	V <sub>CC</sub> = 3.0V <sub>dc</sub> , V <sub>BE</sub> = -0.5V <sub>dc</sub>	NPN	-	35	ns
		V <sub>CC</sub> = -3.0V <sub>dc</sub> , V <sub>BE</sub> = 0.5V <sub>dc</sub>	PNP	-	35	
Rise Time	t <sub>r</sub>	I <sub>C</sub> = 10mA <sub>dc</sub> , I <sub>B1</sub> = 1.0mA <sub>dc</sub>	NPN	-	35	ns
		I <sub>C</sub> = -10mA <sub>dc</sub> , I <sub>B1</sub> = -1.0mA <sub>dc</sub>	PNP	-	35	
Storage Time	t <sub>s</sub>	V <sub>CC</sub> = 3.0V <sub>dc</sub> , I <sub>C</sub> = 10mA <sub>dc</sub>	NPN	-	200	ns
		V <sub>CC</sub> = -3.0V <sub>dc</sub> , I <sub>C</sub> = -10mA <sub>dc</sub>	PNP	-	225	
Fall Time	t <sub>f</sub>	I <sub>B1</sub> = I <sub>B2</sub> = 1.0mA <sub>dc</sub>	NPN	-	50	ns
		I <sub>B1</sub> = I <sub>B2</sub> = -1.0mA <sub>dc</sub>	PNP	-	75	

**TYPICAL CHARACTERISTICS**

**NPN**

Figure 1. Delay and Rise Time

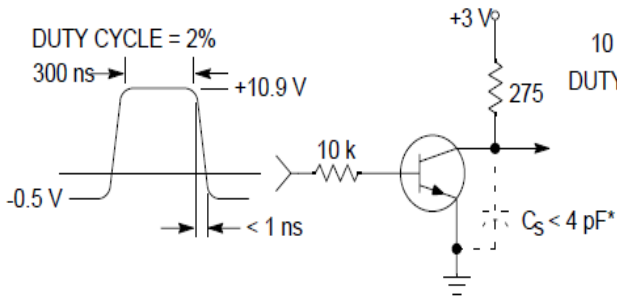
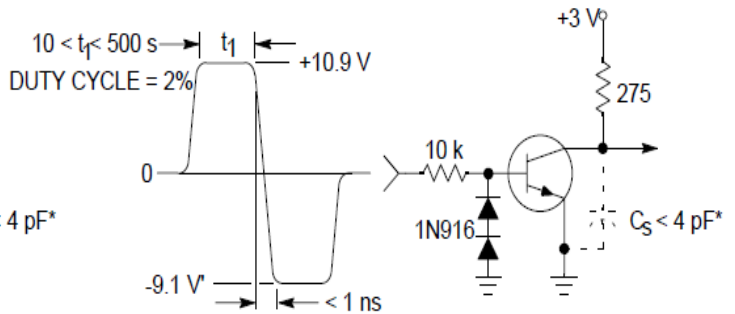

Figure 2. Storage and Fall Time



\* Total shunt capacitance of test jig and connectors

—  $T_J = 25^\circ\text{C}$   
- - -  $T_J = 125^\circ\text{C}$

Figure 3. Capacitance

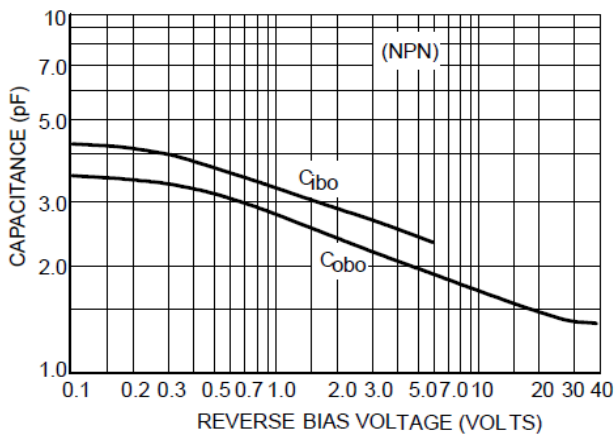

Figure 4. Charge Data

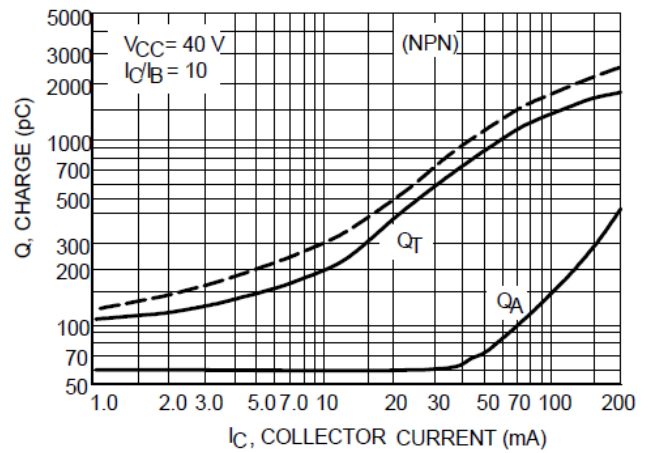



Figure 5. Turn±On Time

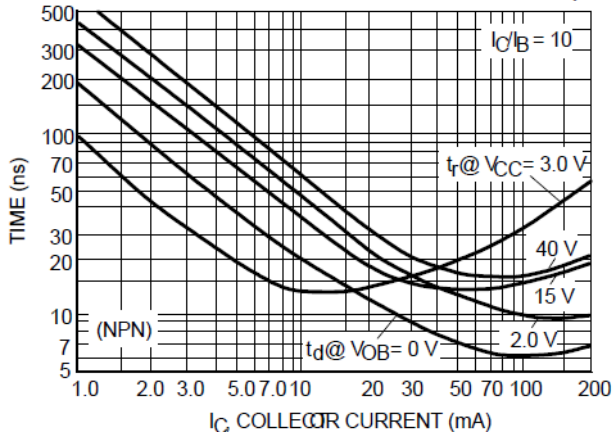

Figure 6. Rise Time

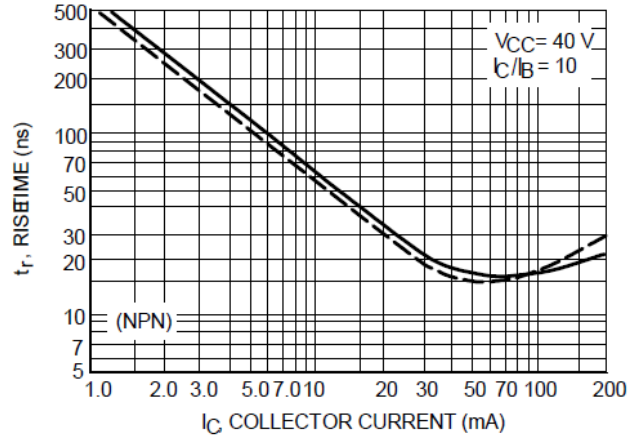

Figure 7 Storage Time

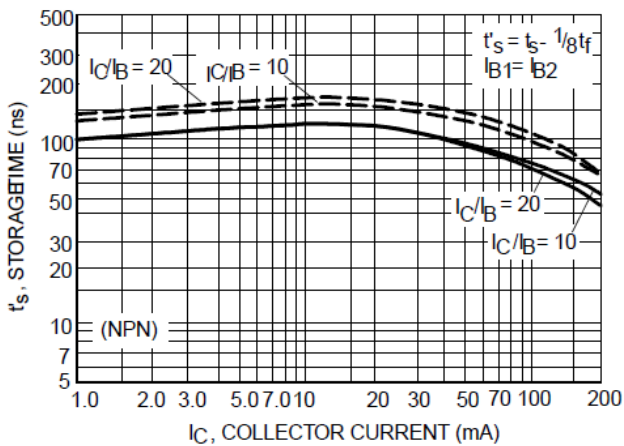
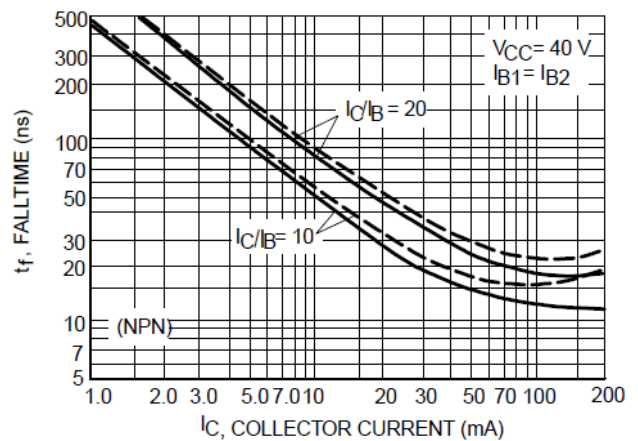

Figure 8 Fall Time



**TYPICAL AUDIO SMALL-SIGNAL CHARACTERISTICS NOISE FIGURE VARIATIONS**

$V_{CE} = 5.0V_{dc}$ ,  $T_A = 255^\circ C$ , Bandwidth = 1.0 Hz

Figure 9. Noise Figure

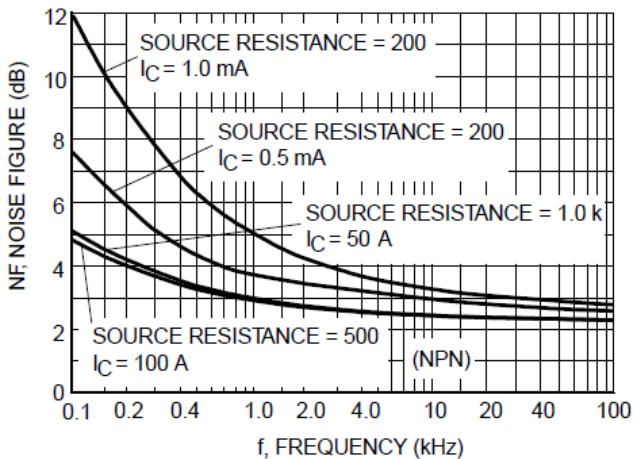
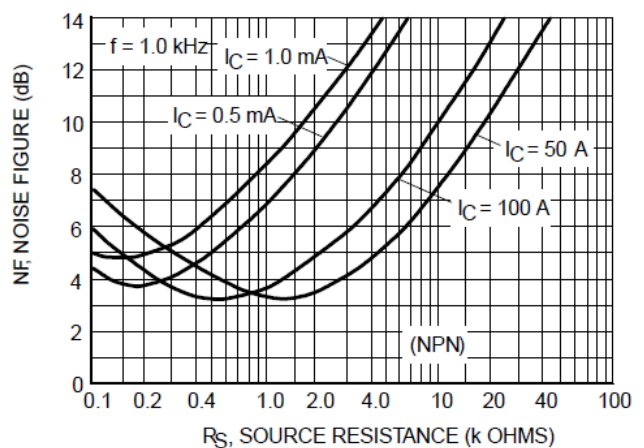

Figure 10. Noise Figure





**h PARAMETERS**  $V_{CE} = 10V_{dc}$ ,  $f = 1.0kHz$ ,  $T_A = 25^\circ C$

Figure 11. Current Gain

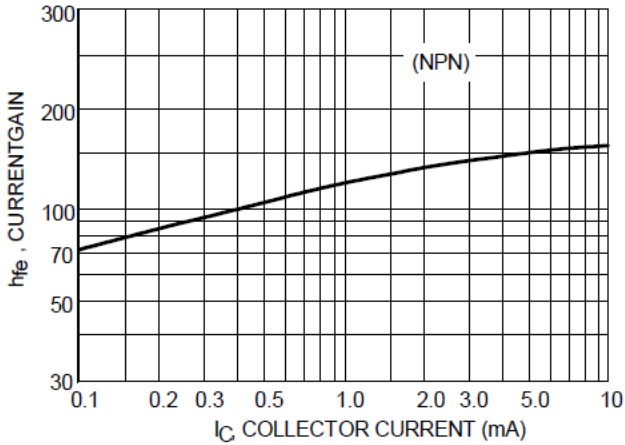

Figure 12. Output Admittance

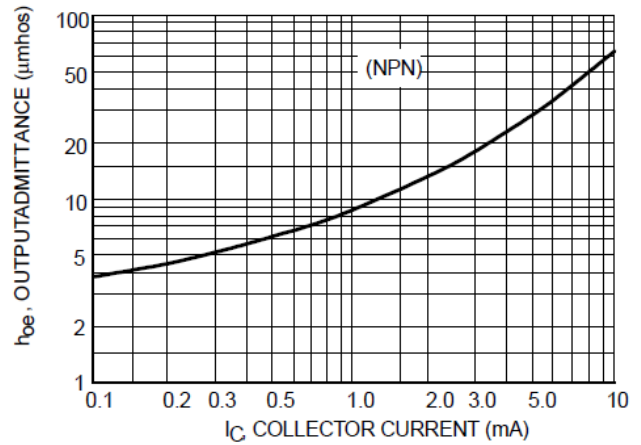

Figure 13. Input Impedance

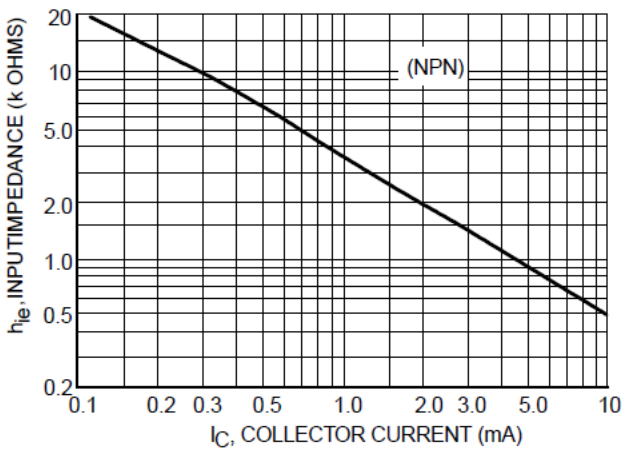

Figure 14. Voltage Feedback Ratio

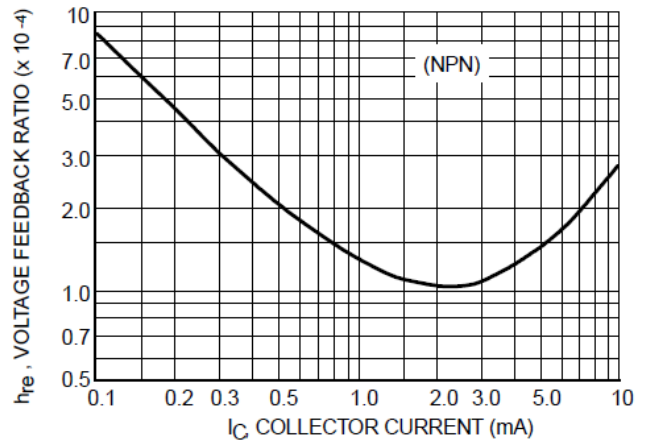



Figure 15. DC Current Gain

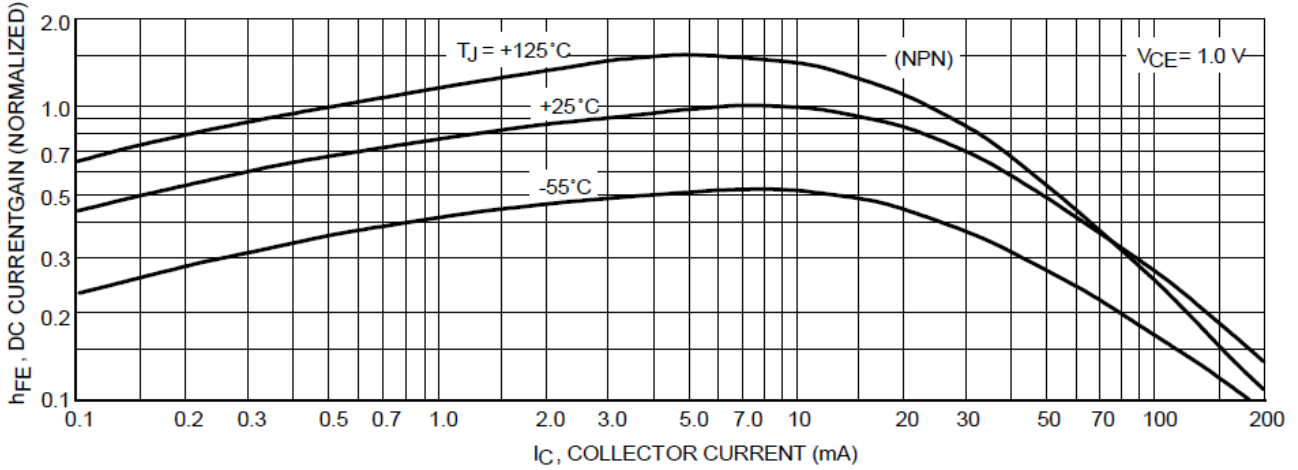

Figure 16. Collector Saturation Region

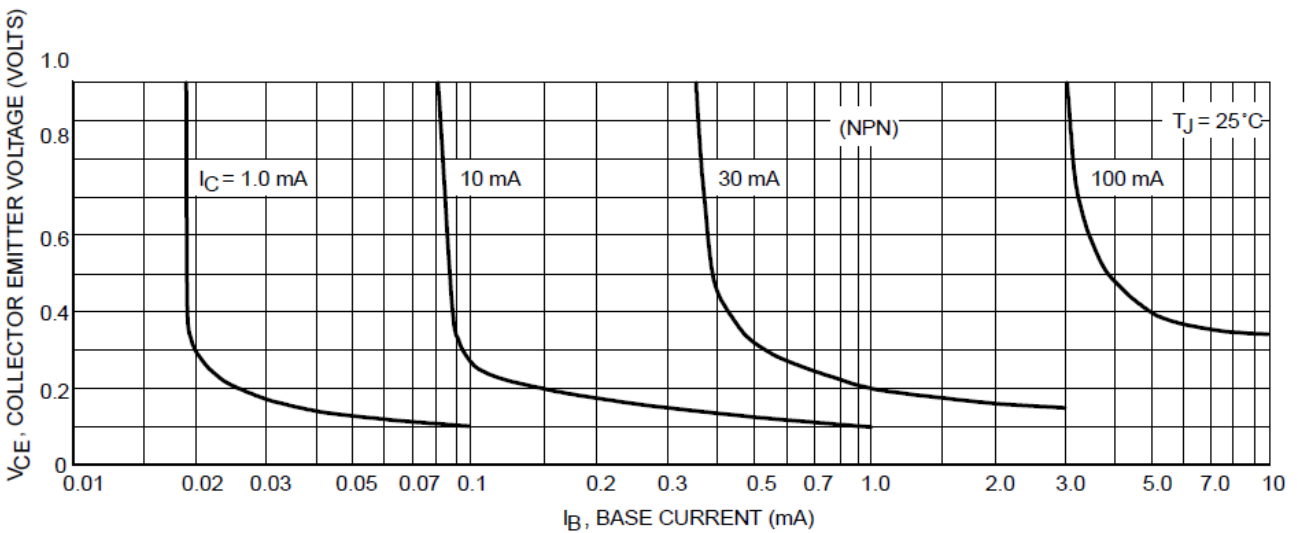

Figure 17. "ON" Voltages

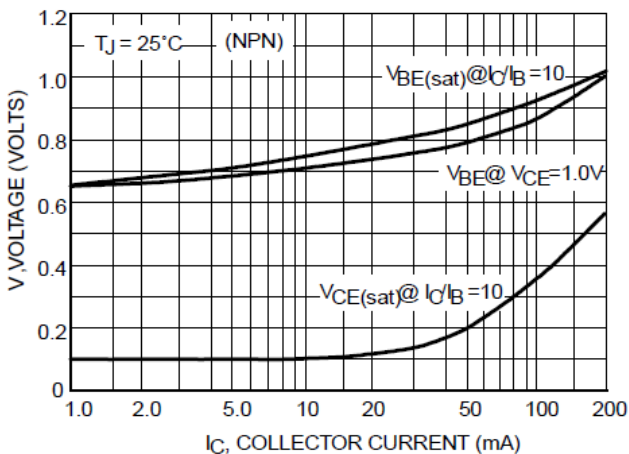
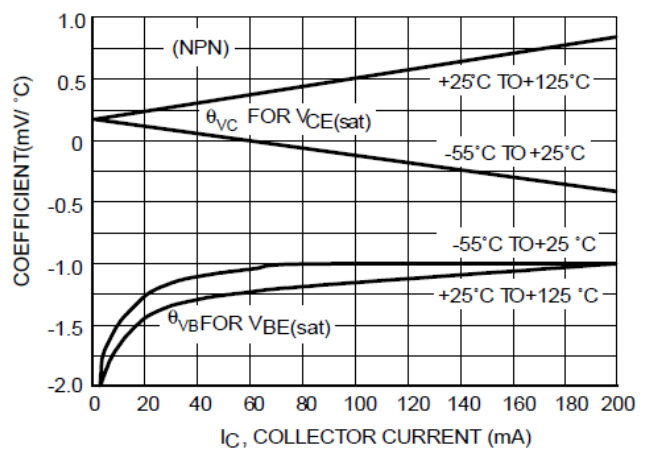

Figure 18. Temperature Coefficients





**PNP**

Figure 19. Delay and Rise Time Equivalent Test Circuit

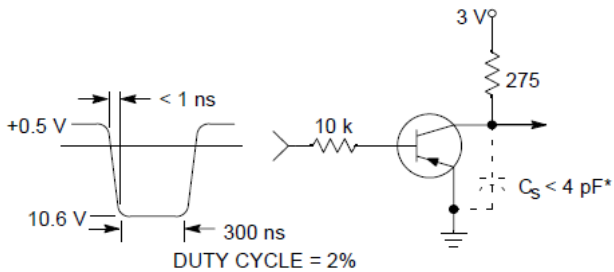
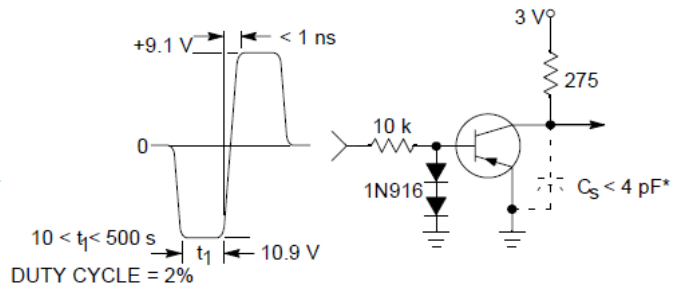

Figure 20. Storage and Fall Time Equivalent Test Circuit



\* Total shunt capacitance of test jig and connectors

—  $T_J = 25^\circ\text{C}$   
- - -  $T_J = 125^\circ\text{C}$

Figure 21. Capacitance

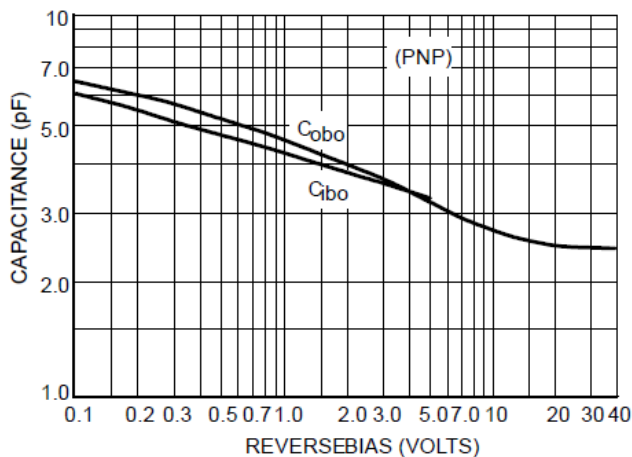

Figure 22. Charge Data

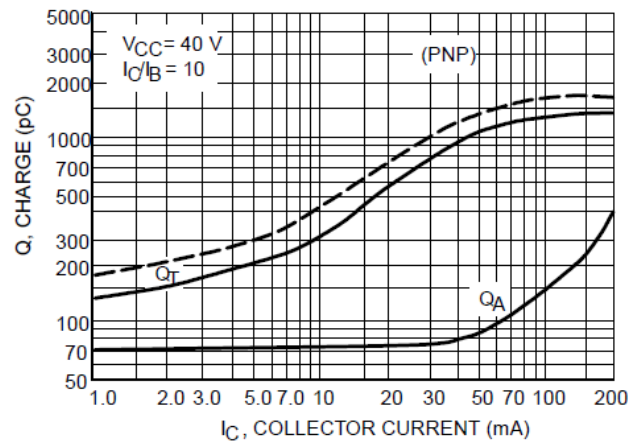

Figure 23. Turn-On Time

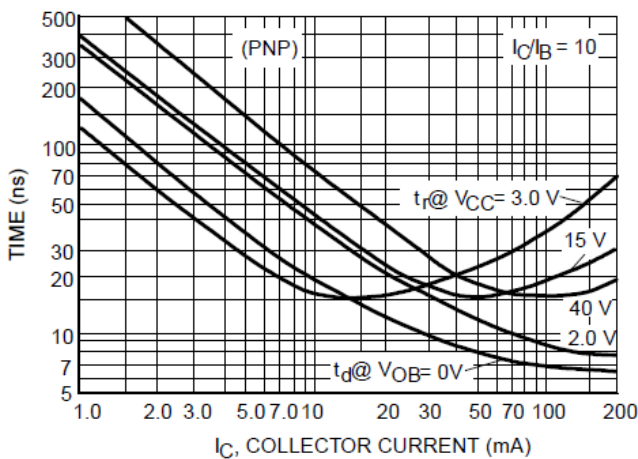
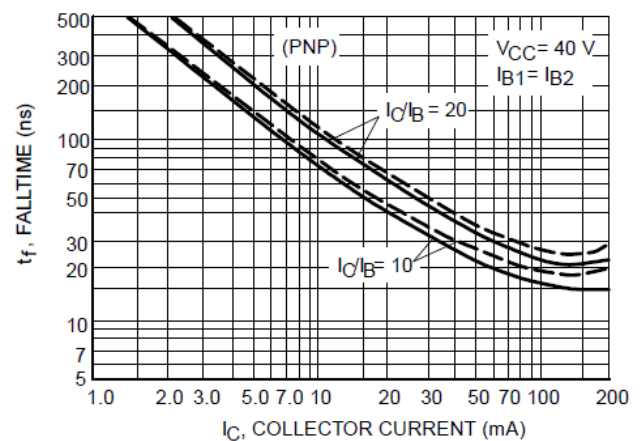

Figure 24. Fall Time





### TYPICAL AUDIO SMALL-SIGNAL CHARACTERISTICS NOISE FIGURE VARIATIONS

$V_{CE} = \pm 5.0V_{dc}$ ,  $T_A = 25^\circ C$ , Bandwidth = 1.0 Hz

Figure 25

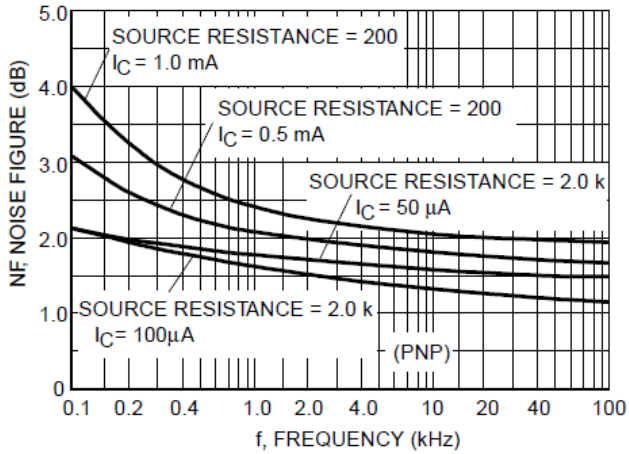
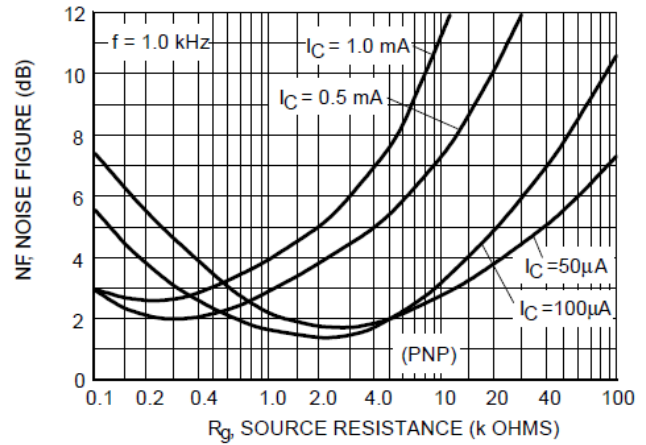

Figure 26



**h PARAMETERS**  $V_{CE} = \pm 10V_{dc}$ ,  $f = 1.0kHz$ ,  $T_A = 25^\circ C$

Figure 27. Current Gain

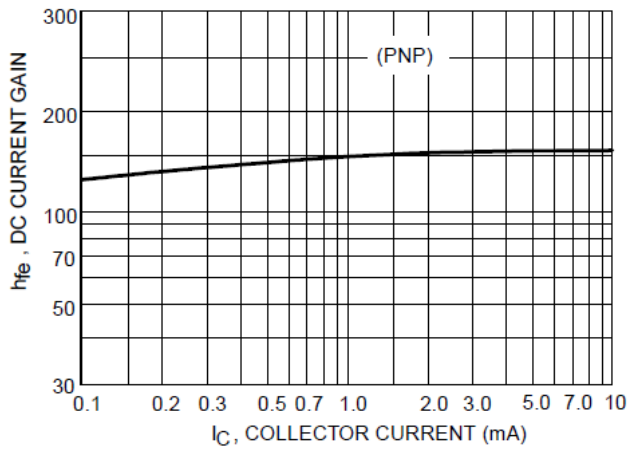

Figure 28. Output Admittance

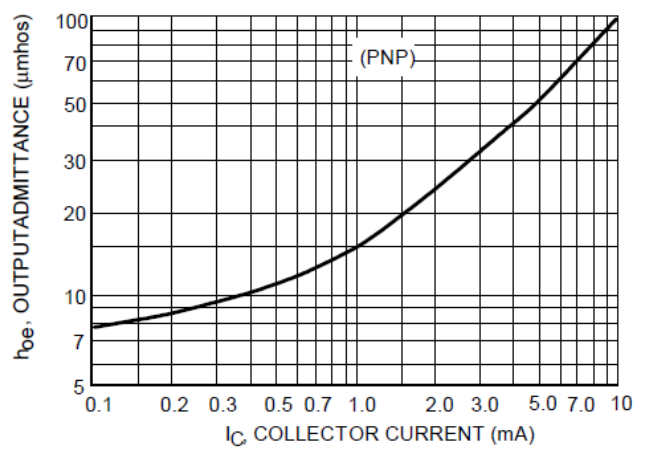

Figure 29. Input Impedance

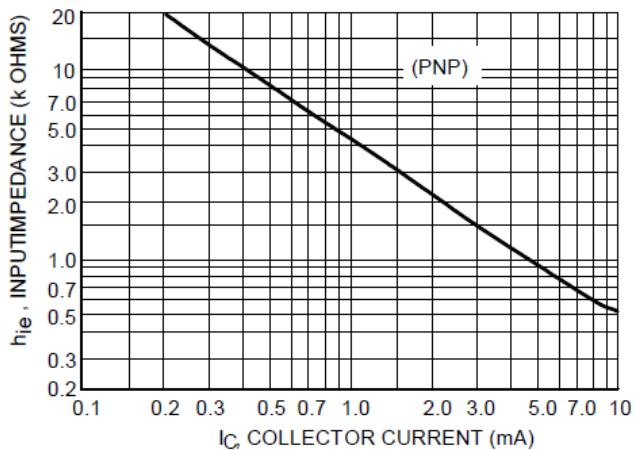

Figure 30. Voltage Feedback Ratio

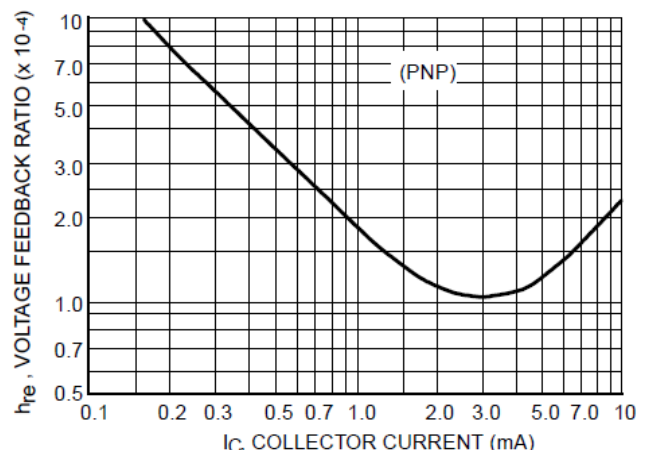



Figure 31. DC Current Gain

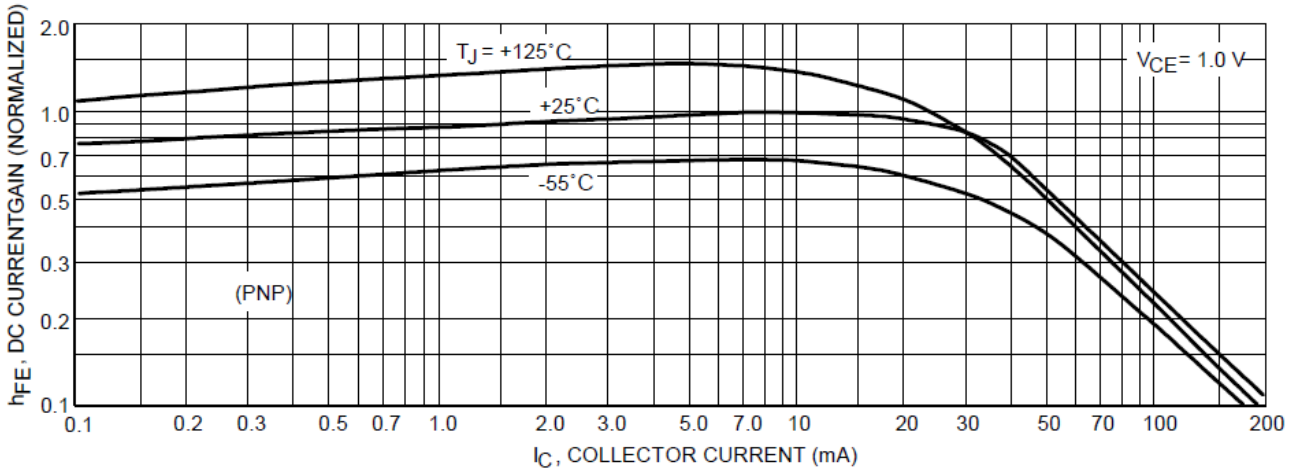

Figure 32. Collector Saturation Region

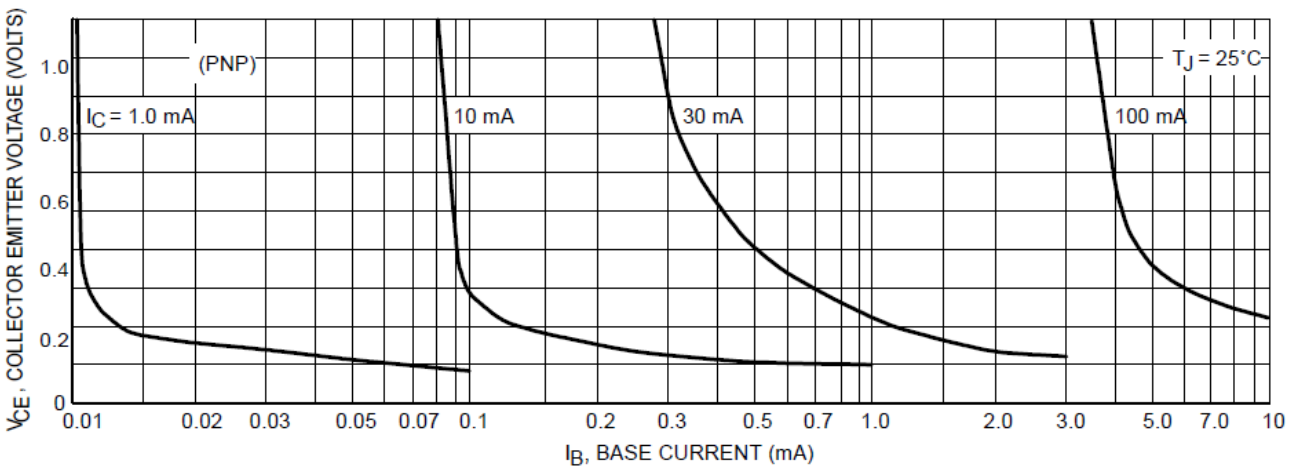

Figure 33. "ON" Voltages

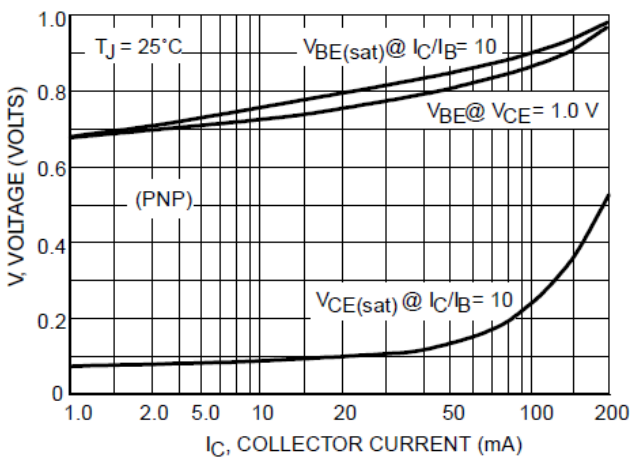
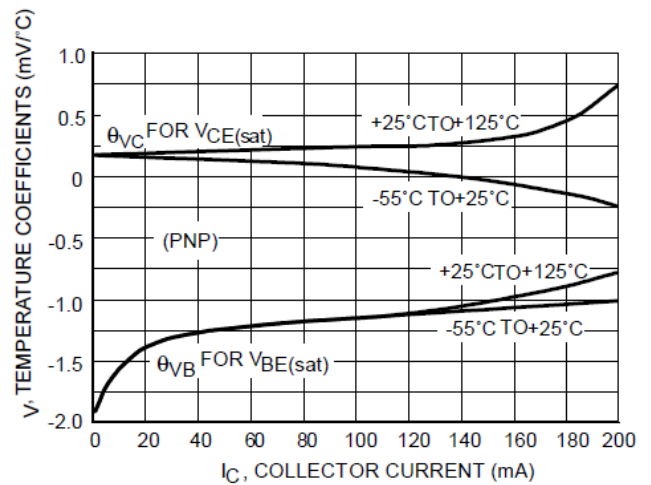

Figure 34. Temperature Coefficients





**PACKAGE INFORMATION**

Dimension in SC-88 Package (Unit: mm)

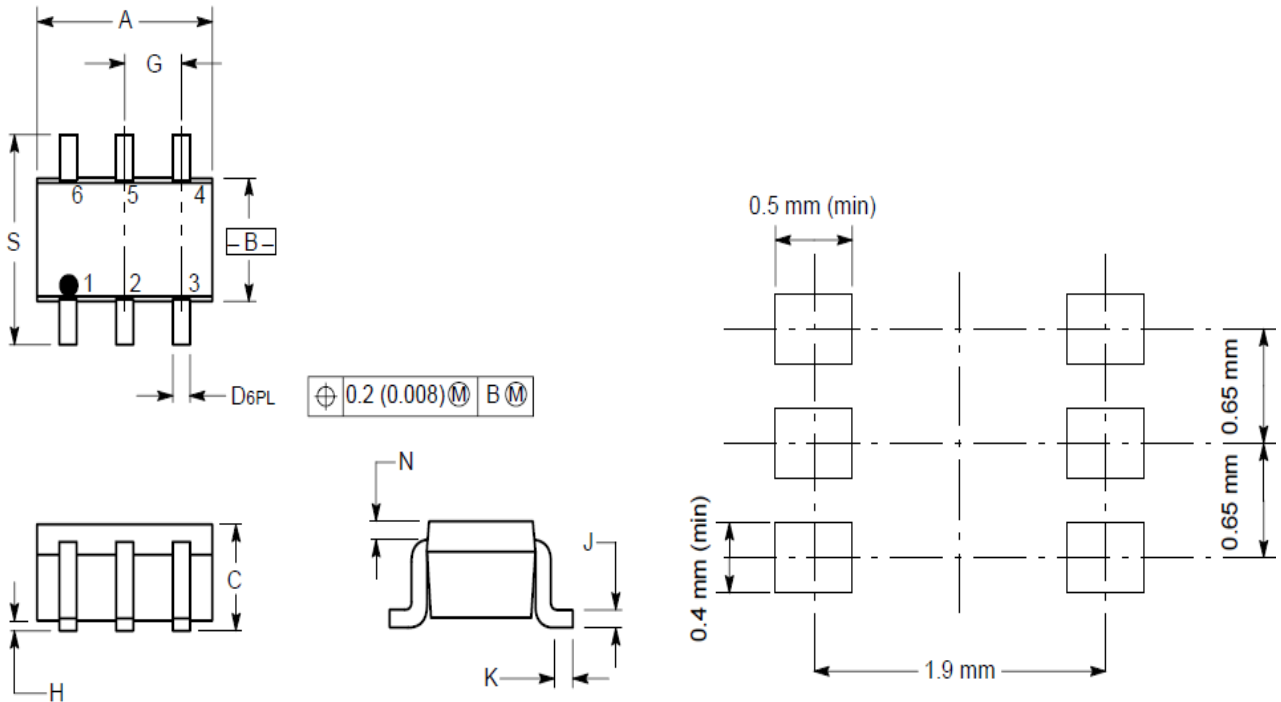

DIM	INCHES		MILLIMETERS	
	MIN	MAX	MIN	MAX
A	0.071	0.087	1.80	2.20
B	0.045	0.053	1.15	1.35
C	0.031	0.043	0.80	1.10
D	0.004	0.012	0.10	0.30
G	0.026 BSC		0.65 BSC	
H	-	0.004	-	0.10
J	0.004	0.010	0.10	0.25
K	0.004	0.012	0.10	0.30
N	0.008 REF		0.20 REF	
S	0.079	0.087	2.00	2.20



## IMPORTANT NOTICE

AiT Components (AiT) reserves the right to make changes to any its product, specifications, to discontinue any integrated circuit product or service without notice, and advises its customers to obtain the latest version of relevant information to verify, before placing orders, that the information being relied on is current.

AiT Components' integrated circuit products are not designed, intended, authorized, or warranted to be suitable for use in life support applications, devices or systems or other critical applications. Use of AiT products in such applications is understood to be fully at the risk of the customer. As used herein may involve potential risks of death, personal injury, or severe property, or environmental damage. In order to minimize risks associated with the customer's applications, the customer should provide adequate design and operating safeguards.

AiT Components assumes to no liability to customer product design or application support. AiT warrants the performance of its products of the specifications applicable at the time of sale.